

Single relay - REL-MR-230AC/21-21/MS



2987972

<https://www.phoenixcontact.com/fr/produits/2987972>

Please be informed that the data shown in this PDF document is generated from our Online Catalog. Please find the complete data in the user documentation. Our General Terms of Use for Downloads are valid.



Plug-in miniature relay, with power contact, 2 changeover contacts, test button, mechanical switching position indicator, status LED, coil voltage 230 V AC

Your advantages

- With detectable manual operation
- DC types with integrated freewheeling diode
- Integrated status LED
- Switching current of up to 16 A
- Mechanical switch position indicator

Commercial Data

Item number	2987972
Packing unit	10 pc
Minimum order quantity	10 pc
Sales Key	CK6195
Product Key	CK6195
Catalog Page	Page 292 (C-5-2019)
GTIN	4046356480987
Weight per Piece (including packing)	19.19 g
Weight per Piece (excluding packing)	17.99 g
Customs tariff number	85364900
Country of origin	CN

Single relay - REL-MR-230AC/21-21/MS



2987972

<https://www.phoenixcontact.com/fr/produits/2987972>

Technical Data

Product properties

Product type	Single relay
Set comprises	2905292 RIF-1-RPT-LV-230AC/2X21MS
	2905662 RIF-1-RSC-LV-230AC/2X21MS
Mechanical service life	5x 10 ⁶ cycles

Electrical properties

Service life electrical	see diagram
Maximum power dissipation for nominal condition	0.81 W
Test voltage (Winding/contact)	5 kV AC (50 Hz, 1 min., winding/contact)
Test voltage (Contact/contact)	2.5 kV AC (50 Hz, 1 min., contact/contact)

Input data

Coil side

Nominal input voltage U_N	230 V AC
Input voltage range	179.4 V AC ... 333.5 V AC
Mains frequency	50/60 Hz
Typical input current at U_N	3.5 mA
Typical response time	3 ms ... 12 ms (depending on phase relation)
Typical release time range	2 ms ... 8 ms (depending on phase relation)

Output data

Switching

Contact type	2 changeover contacts
Type of switch contact	Single contact
Drive and function	monostable
Contact material	AgNi
Maximum switching voltage	250 V AC/DC
Minimum switching voltage	12 V (at 10 mA)
Limiting continuous current	8 A
Maximum inrush current	16 A (20 ms)
Min. switching current	10 mA (at 12 V)
Interrupting rating (ohmic load) max.	2000 VA (for 250 V AC)
Switching capacity	1 A (at 24 V, DC13)
	1.5 A (at 24 V, AC15)
	1.5 A (at 120 V, AC15)
	1.5 A (at 240 V, AC15)
Motor load according to UL 508	1/4 HP, 120 V AC (N/O contact)
	1/2 HP, 240 V AC (N/O contact)
	1/4 HP, 120 V AC (N/C contact)

Single relay - REL-MR-230AC/21-21/MS



2987972

<https://www.phoenixcontact.com/fr/produits/2987972>

1/3 HP, 240 V AC (N/C contact)

Connection data

Connection method

Plug / solder connection

Dimensions

Dimensional drawing

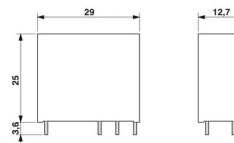

Width

12.7 mm

Height

29 mm

Depth

25 mm

Environmental and real-life conditions

Ambient conditions

Ambient temperature (operation)

-40 °C ... 70 °C

Ambient temperature (storage/transport)

-40 °C ... 85 °C

Approval data

Corrosive gas test

Identification

ISA-S71.04. G3 Harsh Group

EN 60068-2-60

Standards and regulations

Standards/regulations

EN 61810-1

VDE 0435-201

EN 50178

Single relay - REL-MR-230AC/21-21/MS



2987972

<https://www.phoenixcontact.com/fr/produits/2987972>

Drawings

Diagram

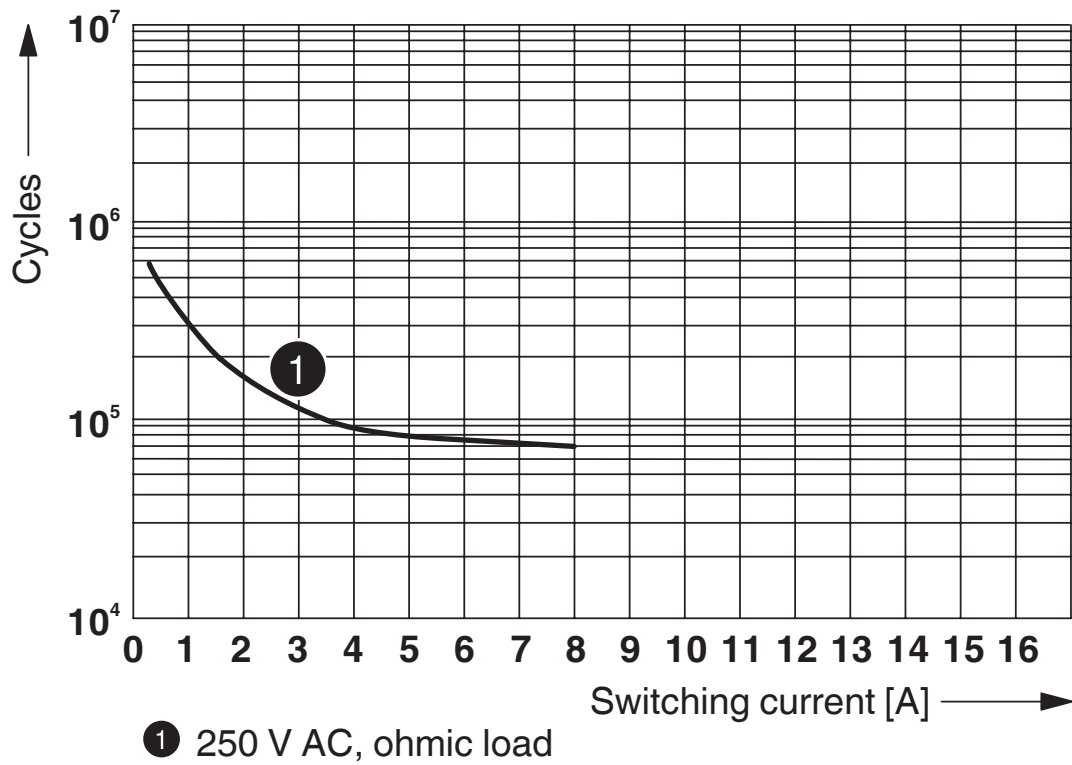

Electrical service life

Diagram

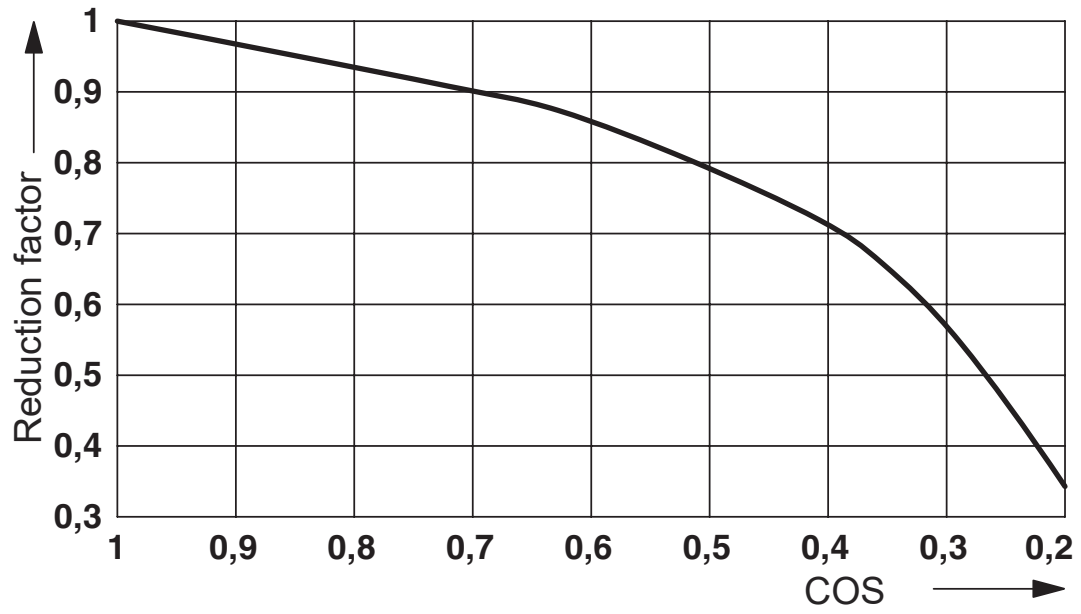

Service life reduction factor with various cos phi

Single relay - REL-MR-230AC/21-21/MS



2987972

<https://www.phoenixcontact.com/fr/produits/2987972>

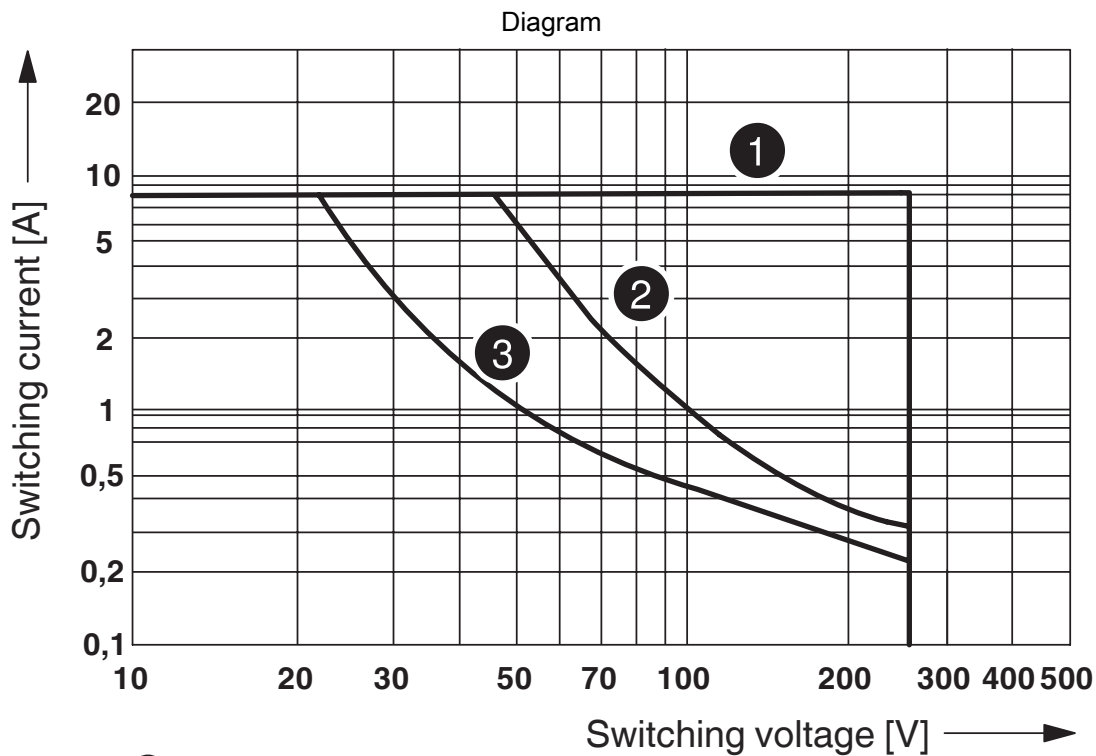

- ① AC, ohmic load
- ② DC, ohmic load, contacts in series
- ③ DC, ohmic load

Interrupting rating

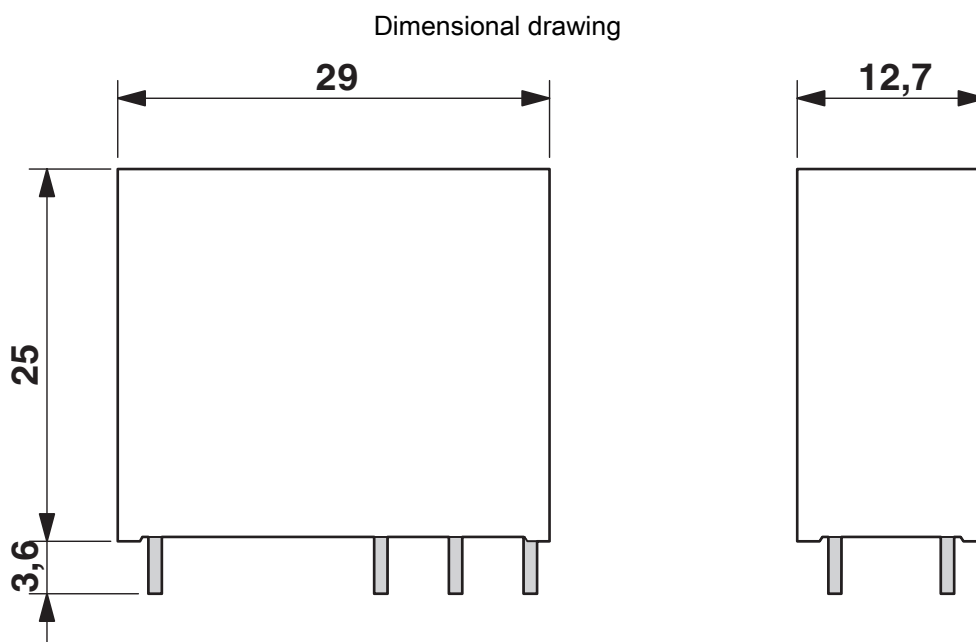

Single relay - REL-MR-230AC/21-21/MS

2987972

<https://www.phoenixcontact.com/fr/produits/2987972>

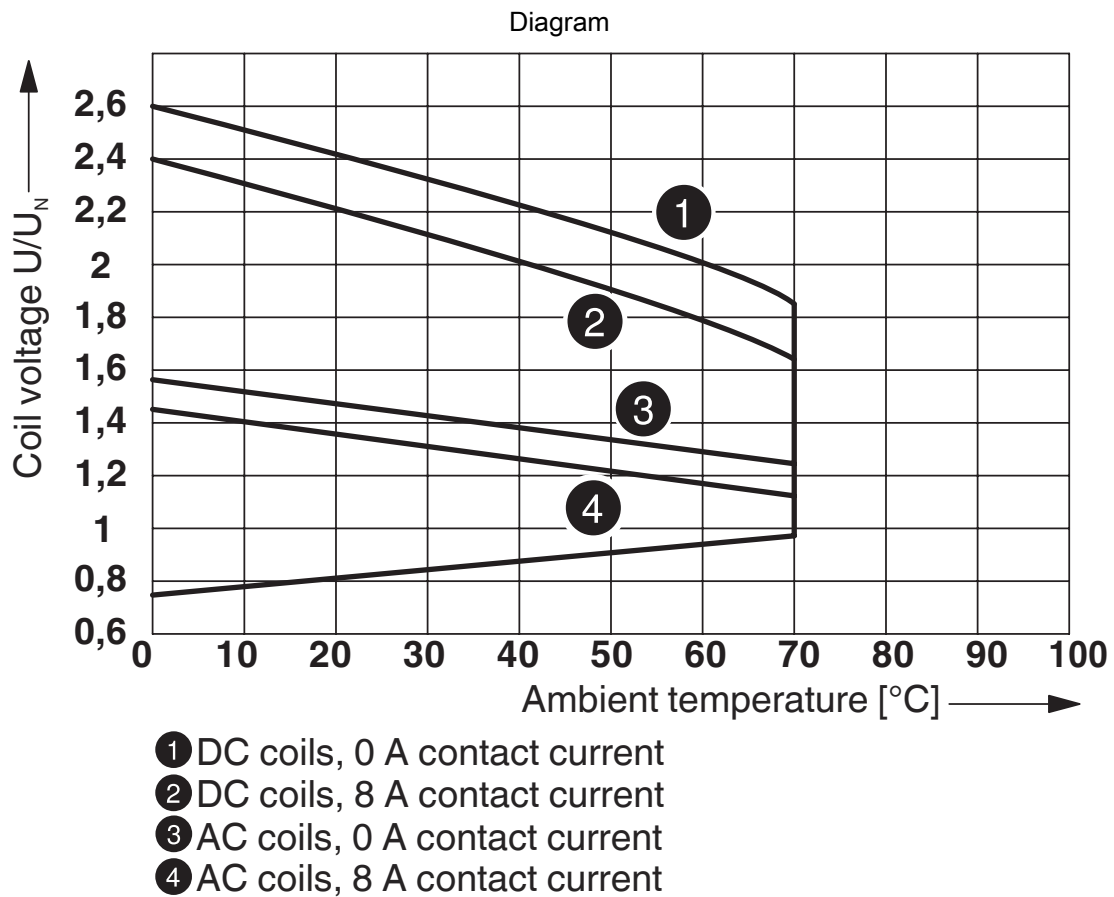

Operating voltage range

Single relay - REL-MR-230AC/21-21/MS



2987972

<https://www.phoenixcontact.com/fr/produits/2987972>

Approvals



cUL Recognized
Approval ID: FILE E 195083



UL Recognized
Approval ID: FILE E 195083



EAC
Approval ID: TR_TS_D_00573_c



EAC
Approval ID: RU*C-DE.*08.B.00010



VDE Zeichengenehmigung
Approval ID: 40027210

	Nominal Voltage U_N	Nominal Current I_N	Cross Section AWG	Cross Section mm^2
Mark approval certificate			-	-

cULus Recognized

Single relay - REL-MR-230AC/21-21/MS



2987972

<https://www.phoenixcontact.com/fr/produits/2987972>

Classifications

ECLASS

ECLASS-9.0	27371601
ECLASS-10.0.1	27371601
ECLASS-11.0	27371601

ETIM

ETIM 8.0	EC001437
----------	----------

UNSPSC

UNSPSC 21.0	39122300
-------------	----------

Single relay - REL-MR-230AC/21-21/MS



2987972

<https://www.phoenixcontact.com/fr/produits/2987972>

Environmental Product Compliance

China RoHS	Environmentally friendly use period: unlimited = EFUP-e
	No hazardous substances above threshold values

Single relay - REL-MR-230AC/21-21/MS



2987972

<https://www.phoenixcontact.com/fr/produits/2987972>

Accessories

Relay base

Relay base - RIF-1-BPT/2X21 - 2900931

<https://www.phoenixcontact.com/fr/produits/2900931>



Relay base RIF-1..., for miniature power relay with 1 or 2 changeover contacts or solid-state relays of the same design, Push-in connection, plug-in option for input/interference suppression modules, for mounting on NS 35/7,5

Relay base

Relay base - RIF-1-BSC/2X21 - 2900930

<https://www.phoenixcontact.com/fr/produits/2900930>

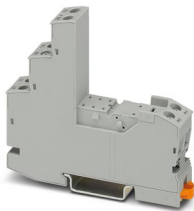

RIF-1... relay base, for miniature power relay with 1 or 2 changeover contacts or identical solid-state relays, screw connection, plug-in option for input/interference suppression modules, for mounting on NS 35/7,5

Phoenix Contact 2023 © - all rights reserved

<https://www.phoenixcontact.com>

PHOENIX CONTACT SAS

52 Boulevard de Beaubourg Emerainville

77436 Marne La Vallée Cedex 2 France

+33 (0) 1 60 17 98 98

documentation@phoenixcontact.fr